

Universal Serial Bus Specification Revision 2.0
Keysight Method of Implementation (MOI) for USB 2.0
Connectors and Cables Assemblies Compliance Tests
Using Keysight E5071C ENA Option TDR

Table of Contents

1.	Revision History	3
2.	Purpose	3
3.	References	3
4.	Required Equipment	3
5.	Test Procedure	4
5.1.	Outline of Test Procedure	4
5.2.	Setup	6
5.2.1.	Recalling a State File	6
5.2.2.	Saving a State File	7
5.3.	Calibration	8
5.3.1.	Time Domain Calibration	8
5.3.2.	Frequency Domain Calibration	13
5.3.3.	Adjustment of Effective Rise Time	15
5.4.	Measurement	18
5.4.1.	Cable Impedance (High/Full-Speed)	18
5.4.2.	Propagation Delay	18
5.4.3.	Propagation Delay Skew	19
5.4.4.	Signal Pair Attenuation (High/Full-Speed)	20
6.	[Appendix] Manual Setup	21
6.1.	Channel & Trace Setup	21
6.2.	Cable Impedance (High/Full-Speed)	22
6.3.	Propagation Delay	24
6.4.	Propagation Delay Skew	25
6.4.1.	Parameter Setup	25
6.4.2.	Crosstalk Compensation	26
6.5.	Common Parameters Setup for Frequency-domain Measurements	27
6.6.	Signal Pair Attenuation (High/Full-Speed)	28
6.7.	Defining Limit Line Tables	28
7.	[Appendix] Defining SOLT Calibration Kit	29

1. Revision History

Revision	Comments	Issue Date
1.00	Initial Revision.	Sep. 24, 2014

2. Purpose

This test procedure was written to explain how to use the Keysight ENA Option TDR to make the connectors and cable assemblies measurements required per USB Specification Revision 2.0 and Cables and Connectors Class Document Revision 2.0.

3. References

- Universal Serial Bus Specification Revision 2.0 (April 27, 2000)
- Universal Serial Bus Cables and Connectors Class Document Revision 2.0 (August 2007)

4. Required Equipment

Description	Test Equipment	QTY
Network Analyzer	Keysight E5071C ENA Series Network Analyzer <ul style="list-style-type: none"> ➤ Option 440/445/460/465/480/485/4DK/4K5 (one of port/freq. options) ➤ Option TDR (Enhanced time domain analysis) 	1 ea.
4-port ECal or Mechanical Cal Kit	Keysight N4431B or 85033E (E5071C-44x/46x/48x) Keysight N4433A or 85052D (E5071C-4D5/4K5)	1 ea.
Test Fixture	USB 3.0 official test fixture	1 ea.
Adapter	1250-1744 3.5 mm(f)-Type N(m) adapter (E5071C-44x/46x/48x) or 83059B coaxial adapter (E5071C-4DK/4K5) for E5071C ports	4 ea.
RF cable	3.5 mm or SMA cables of 4 GHz bandwidth or more	4 ea.
50 ohm Terminator	Termination for unused differential pairs (ex. Keysight 909D-301)	12 ea.

Note: Signal pair attenuation test requires the test frequency from 64 kHz. When using E5071C-4x5, the lower frequency is limited to either 100 kHz or 300 kHz depending on the frequency option.

5. Test Procedure

5.1. Outline of Test Procedure

1. Setup

- Instrument, RF cables and test fixture setup
- Automatic setup by recalling a state file or manual setup

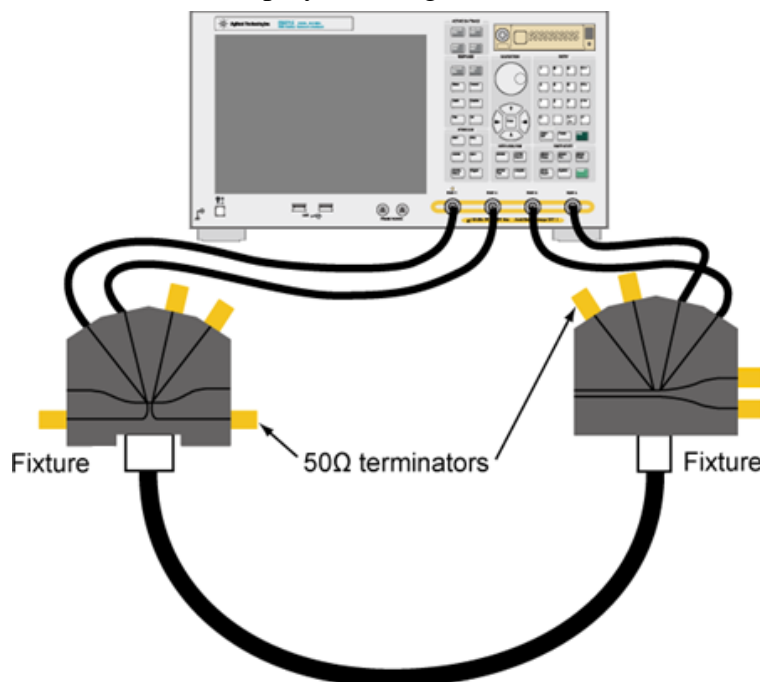

2. Calibration

- ECal Calibration & Fixture Compensation or Deskew & Loss Compensation
- SOLT Calibration
- Adjustment of Effective Rise Time

3. Measurements

4-1. Time-domain Measurements

- Cable Impedance (High/Full-Speed)
- Propagation Delay
- Propagation Delay Skew

4-2. Frequency-domain Measurements

- Signal Pair Attenuation (High/Full-Speed)

Keysight MOI for USB 2.0 Connectors & Cable Assemblies Compliance Tests

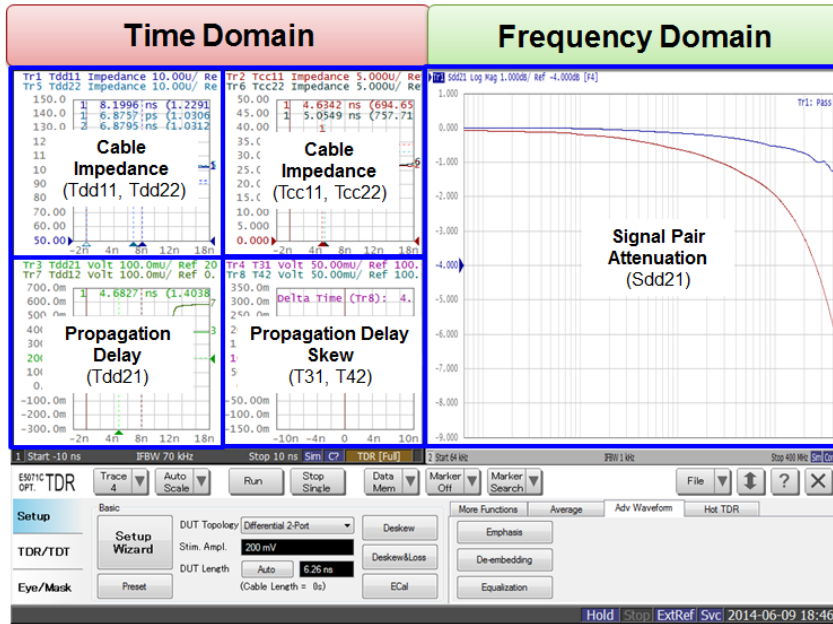

Note: Hard keys (Keys on the E5071C's front panel) are displayed in **Blue color** and **Bold**.

(Example: **Avg, Analysis**)

Note: Soft keys (Keys on the E5071C's screen) are displayed in **Bold**.

(Example: **S11, Real, Transform**)

Note: Buttons of the TDR software are displayed in **Green color** and **Bold**.

(Example: **Trace, Rise Time**)

Note: Tabs of the TDR software are displayed in **Brown color** and **Bold**.

(Example: **Setup, Trace Control**)

5.2.Setup

5.2.1. Recalling a State File

This section describes how to recall a state file of the E5071C that includes all the measurement settings for USB2.0 connectors and cable assemblies compliance tests.

The state file can be downloaded at: http://www.keysight.com/find/ena-tdr_compliance

Copy the state file into the E5071C's directory via USB mass storage device and recall the state file using the TDR software. Necessary parameters for testing are automatically set up in the E5071C. Refer to Appendix for the details about manual setup.

If TDR setup wizard is shown, click **Close** button in the TDR setup wizard main window.

1. Open **Setup** tab.
2. Click **Advanced Mode** to show the dialog box.

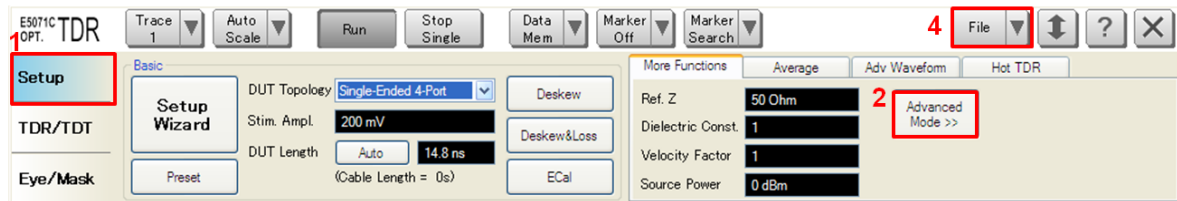

3. A dialog box appears requesting for confirmation. Then click **Yes**. (Uncheck “Use Advanced Calibration Methods”)

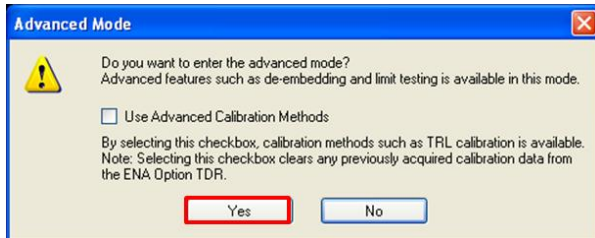

4. Click **File** and select **Recall State**.
5. Specify a folder and a file name, and click **Open**.

The E5071C's channel 1 is used for time-domain measurements by using the TDR software displayed at the bottom of the E5071C's screen. The channel 2 is used for frequency-domain measurements by using the hard keys on the front panel and the soft keys on the right side of the screen.

Keysight MOI for USB 2.0 Connectors & Cable Assemblies Compliance Tests

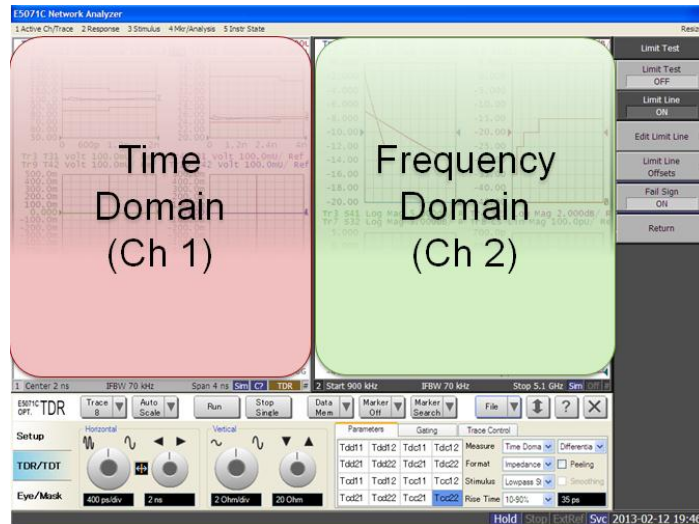

5.2.2. Saving a State File

All the measurement settings including calibration information can be saved in a state file (*.tdr). After performing calibration, all necessary calibration coefficients are saved in a state file and can be recalled for the next measurements.

1. Press **Save/Recall** > **Save Type** and select **State & Cal** as a state file type.
2. Click **File** of the TDR software and select **Save State**.



3. Enter file name and save the state file with calibration information.

5.3. Calibration

The purpose of this step is to calibrate the RF effects such as delay, loss or mismatch of RF cables and test fixture traces before measurements. In order to remove the fixture trace effect, two calibration methods (ECal calibration & fixture compensation or deskew & loss compensation) are available for time domain and SOLT calibration is available for frequency domain with the E5071C firmware for the USB 2.0 connectors and cable assemblies compliance tests.

5.3.1. Time Domain Calibration

5.3.1.1. ECal Calibration & Fixture Compensation

Full calibration is performed by using the ECal Module (i.e. N4431B/N4433A) at the end of RF cables connected to the E5071C's test ports. The effect of the fixture is removed by fixture compensation.

ECal calibration & fixture compensation for time-domain measurements are performed by the TDR software.

1. ECal Calibration & Fixture Compensation

- a) Press **Channel Next** to select Channel 1.
- b) Click **Setup** tab.
- c) Click **ECal** to launch the TDR Setup Wizard.

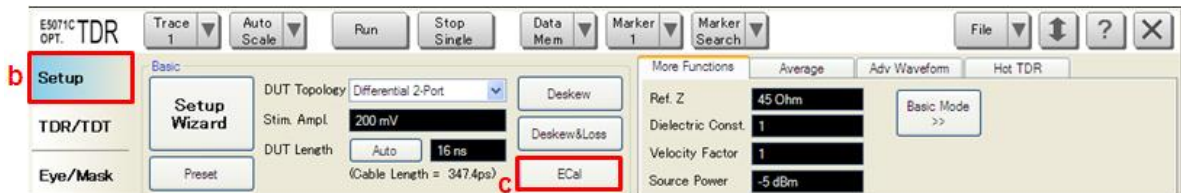

- d) Connect the E5071C ports (port 1 to 4) to the ECal module with RF cables.
- e) Click **Calibrate** to perform ECal Calibration.
- f) Click **Next >**.

Keysight MOI for USB 2.0 Connectors & Cable Assemblies Compliance Tests

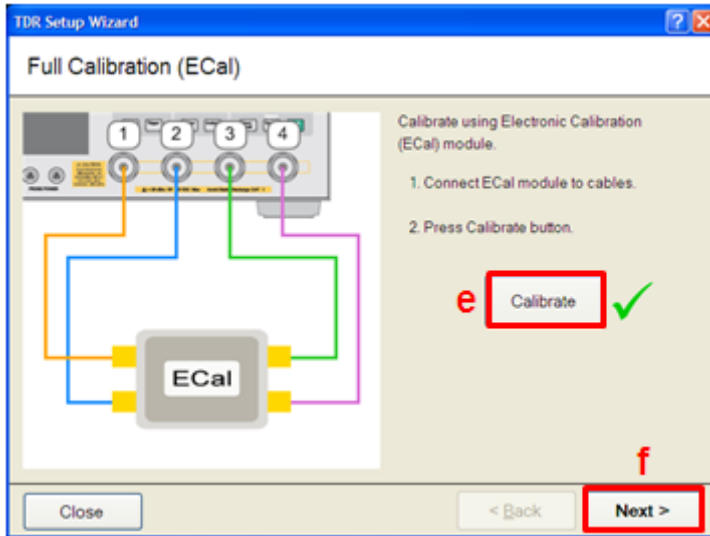

g) Click **Options**.

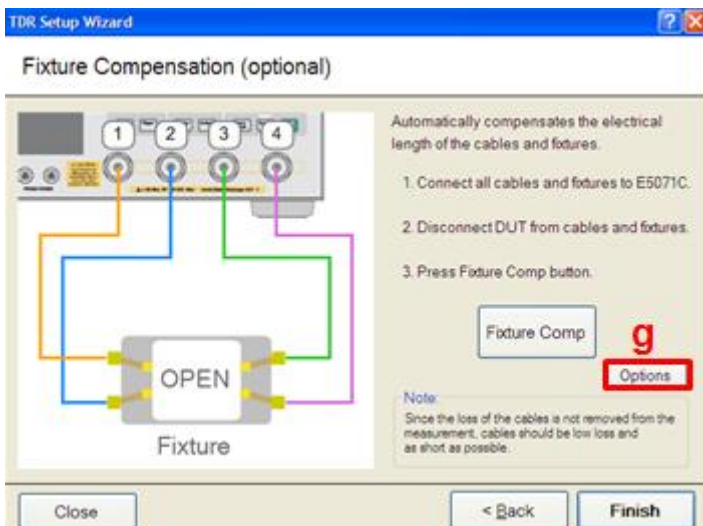

h) Select Standard Type to “Short”.

i) Connect Short standard of USB 3.0 official test fixture to the E5071C port 1 with the RF cable.

j) Click **Port 1**.

k) Connect Short standard of USB 3.0 official test fixture to the E5071C port 2 with the RF cable.

l) Click **Port 2**.

m) Connect Short standard of USB 3.0 official test fixture to the E5071C port 3 with the RF cable.

n) Click **Port 3**.

o) Connect Short standard of USB 3.0 official test fixture to the E5071C port 4 with the RF cable.

p) Click **Port 4**.

q) Click **OK**.



r) Click **Finish**.

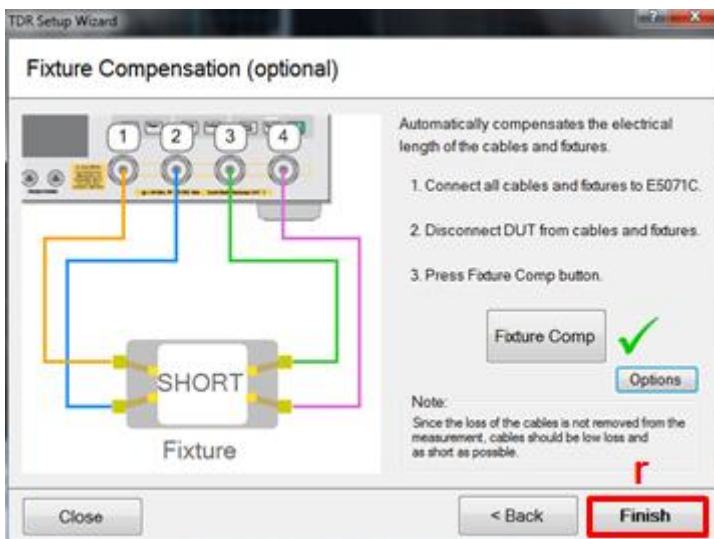

5.3.1.2. Deskew & Loss Compensation

Deskew and loss compensation for time-domain measurements are performed by the TDR software.

1. Deskew and Loss Compensation

a) Press **Channel Next** to select Channel 1.

b) Click **Setup** tab.

c) Click **Deskew&Loss** to launch the TDR Setup Wizard.

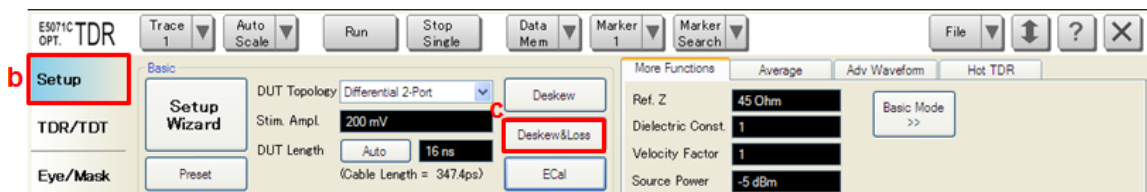

d) Leave RF cables open and click **Deskew**.

e) Click **Next >**.

Keysight MOI for USB 2.0 Connectors & Cable Assemblies Compliance Tests

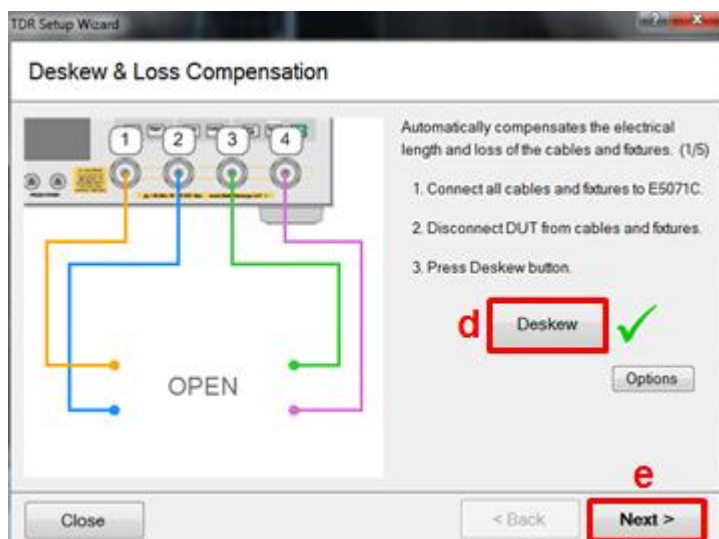

- f) Connect 3.5 mm(f) to 3.5mm(f) adapter of 85033E or 85052D Mechanical Calibration Kit between port 1 and port 3 with RF cables.
- g) Click **Measure**.
- h) Click **Next >**.

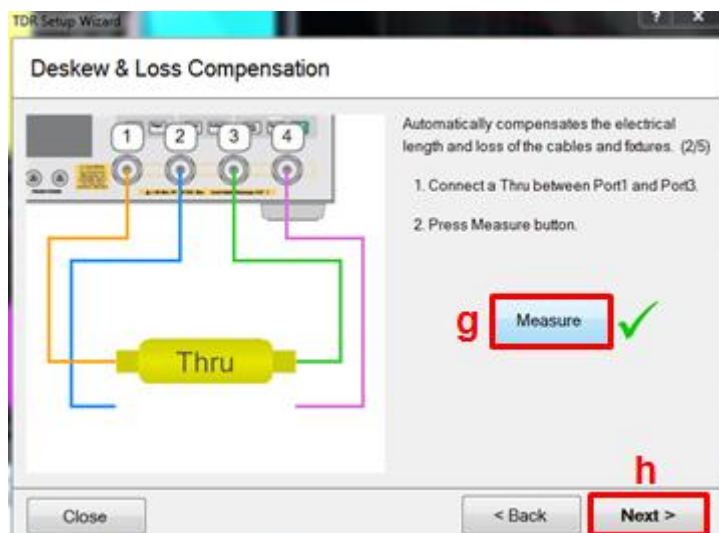

- i) Connect 3.5 mm(f) to 3.5mm(f) adapter of 85033E or 85052D Mechanical Calibration Kit between port 2 and port 4 with RF cables.
- j) Click **Measure**.
- k) Click **Next >**.

Keysight MOI for USB 2.0 Connectors & Cable Assemblies Compliance Tests

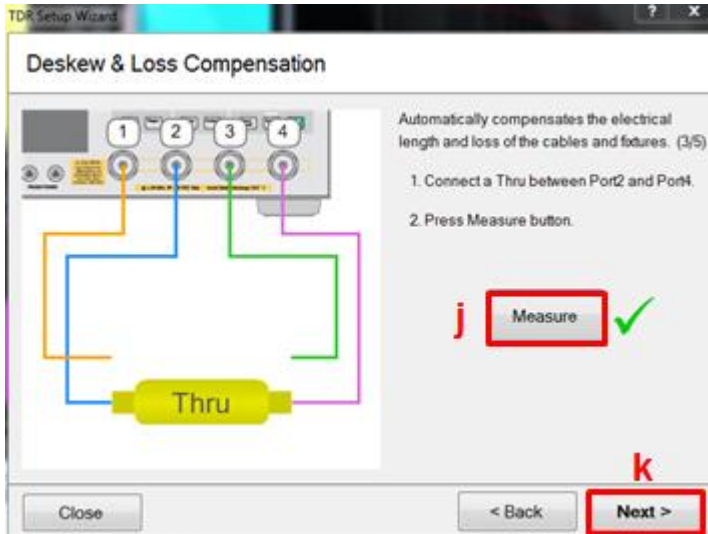

- l) Connect Load standard of 85033E or 85052D Mechanical Calibration Kit to the E5071C port 1 with the RF cable.
- m) Click **Port 1**.
- n) Connect Load standard of 85033E or 85052D Mechanical Calibration Kit to the E5071C port 2 with the RF cable.
- o) Click **Port 2**.
- p) Connect Load standard of 85033E or 85052D Mechanical Calibration Kit to the E5071C port 3 with the RF cable.
- q) Click **Port 3**.
- r) Connect Load standard of 85033E or 85052D Mechanical Calibration Kit to the E5071C port 4 with the RF cable.
- s) Click **Port 4**.
- t) Click **Apply**.
- u) Click **Finish**.

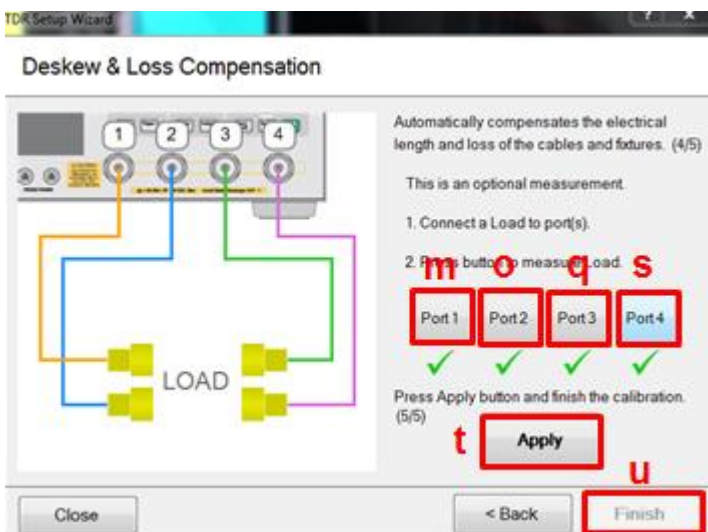

- v) Press **Cal** > **Port Extensions** > **Auto Port Extension** > **Select Ports** to confirm that check-marks are on all the ports (if not, activate it by clicking the port).
- w) Connect Short standard of USB 3.0 official test fixture to the E5071C port 1 with the RF cable.
- x) Press **Cal** > **Port Extensions** > **Auto Port Extension** > **Measure SHORT** > **Port 1**
- y) Connect Short standard of USB 3.0 official test fixture to the E5071C port 2 with the RF cable.
- z) Press **Cal** > **Port Extensions** > **Auto Port Extension** > **Measure SHORT** > **Port 2**
- aa) Connect Short standard of USB 3.0 official test fixture to the E5071C port 3 with the RF cable.
- bb) Press **Cal** > **Port Extensions** > **Auto Port Extension** > **Measure SHORT** > **Port 3**
- cc) Connect Short standard of USB 3.0 official test fixture to the E5071C port 4 with the RF cable.
- dd) Press **Cal** > **Port Extensions** > **Auto Port Extension** > **Measure SHORT** > **Port 4**

5.3.2. Frequency Domain Calibration

SOLT calibration is performed to remove the RF effects (i.e. mismatch, loss or delay) of RF cables and test fixtures. The definition file of the calibration standards is imported to the E5071C, and SOLT calibration is performed with the E5071C firmware by measuring the calibration standards. The calibration is applied for frequency-domain measurements.

5.3.2.1. Selecting Cal Kit

1. Press **Channel Next** to select Channel 2
2. Press **Cal** > **Cal Kit** and select **User**.
3. Press **Cal** > **Modify Cal Kit** > **Import Cal Kit** and select the cal kit definition file (*.ckx) and click **Open**.
4. Confirm that the imported cal kit is set for the selected channel by pressing **Cal** > **Cal Kit**.

5.3.2.2. Performing SOLT Calibration

1. Reflection measurement
 - a) Connect Open standard of USB 3.0 official test fixture to the E5071C port 1 with the RF cable.
 - b) Press **Cal** > **Calibrate** > **4-port Cal** > **Reflection** > **Port1 Open**.

Keysight MOI for USB 2.0 Connectors & Cable Assemblies Compliance Tests

- c) Connect Short standard of USB 3.0 official test fixture to the E5071C port 1 with the RF cable.
 - d) Press **Cal > Calibrate > 4-port Cal > Reflection > Port1 Short.**
 - e) Connect Load standard of USB 3.0 official test fixture to the E5071C port 1 with the RF cable.
 - f) Press **Cal > Calibrate > 4-port Cal > Reflection > Port1 Load.**
 - g) Connect Open standard of USB 3.0 official test fixture to the E5071C port 2 with the RF cable.
 - h) Press **Cal > Calibrate > 4-port Cal > Reflection > Port2 Open.**
 - i) Connect Short standard of USB 3.0 official test fixture to the E5071C port 2 with the RF cable.
 - j) Press **Cal > Calibrate > 4-port Cal > Reflection > Port2 Short.**
 - k) Connect Load standard of USB 3.0 official test fixture to the E5071C port 2 with the RF cable.
 - l) Press **Cal > Calibrate > 4-port Cal > Reflection > Port2 Load.**
 - m) Connect Open standard of USB 3.0 official test fixture to the E5071C port 3 with the RF cable.
 - n) Press **Cal > Calibrate > 4-port Cal > Reflection > Port3 Open.**
 - o) Connect Short standard of USB 3.0 official test fixture to the E5071C port 3 with the RF cable.
 - p) Press **Cal > Calibrate > 4-port Cal > Reflection > Port3 Short.**
 - q) Connect Load standard of USB 3.0 official test fixture to the E5071C port 3 with the RF cable.
 - r) Press **Cal > Calibrate > 4-port Cal > Reflection > Port3 Load.**
 - s) Connect Open standard of USB 3.0 official test fixture to the E5071C port 4 with the RF cable.
 - t) Press **Cal > Calibrate > 4-port Cal > Reflection > Port4 Open.**
 - u) Connect Short standard of USB 3.0 official test fixture to the E5071C port 4 with the RF cable.
 - v) Press **Cal > Calibrate > 4-port Cal > Reflection > Port4 Short.**
 - w) Connect Load standard of USB 3.0 official test fixture to the E5071C port 4 with the RF cable.
 - x) Press **Cal > Calibrate > 4-port Cal > Reflection > Port4 Load.**
2. Transmission measurement
- a) Connect Thru standard of USB 3.0 official test fixture to the E5071C port 1 and port 2 with the RF cable.
 - b) Press **Cal > Calibrate > 4-port Cal > Transmission > Port 1-2 Thru.**
 - c) Connect Thru standard of USB 3.0 official test fixture to the E5071C port 1 and port 3 with the RF cable.

- d) Press **Cal > Calibrate > 4-port Cal > Transmission > Port 1-3 Thru**.
 - e) Connect Thru standard of USB 3.0 official test fixture to the E5071C port 3 and port 4 with the RF cable.
 - f) Press **Cal > Calibrate > 4-port Cal > Transmission > Port 3-4 Thru**.
3. Press **Cal > Calibrate > 4-port Cal > Done** to complete calibration. The calibration coefficients are calculated and the error correction is automatically turned on.

5.3.3. Adjustment of Effective Rise Time

After performing the calibration, the effective rise time entering the USB 3.0 connector pins is adjusted for the specification in time-domain measurements (Table 5-1).

1/2 Thru standard is connected to the E5071C port with RF cables. DUT is disconnected during the adjustment procedure.

Table 5-1 Specification of Effective Rise Time

Trace	Test Items	Rise Time %	Target Rise Time
Tr 1 & 5 & 2 & 6	Cable Impedance	10 – 90 %	200 ps
Tr 3	Propagation Delay	10 – 90 %	200 ps
Tr 4 & 8	Propagation Delay Skew	10 – 90 %	200 ps

1. Press **Channel Next** to select Channel 1.
2. Press **Trace Max** to maximize the selected trace in the screen.
3. Open **TDR/TDT** tab.
4. Adjust effective rise time for each trace with the following procedure.
 - Trace 4 (Trace 8) (Adjust effective rise time for Trace 4 then Trace 8)
 - a) Connect 1/2 Thru standard to the E5071C port 1 (port 2) with the RF cable.
 - b) Click **Trace 4 (Trace 8)**.
 - c) Click **Parameter** tab.
 - d) Select Measure to “Time Domain” and “Single Ended”.
 - e) Select Format to “Volt”.
 - f) Click **Marker Search** and select “Rise Time” (10 – 90 %).
 - g) Click **T11 (T22)**.
 - h) Press **Display > Equation** to turn off the equation editor.
 - i) Click **Run** to measure the rise time on the screen.
 - j) Click **Auto Scale** and select “X&Y”.
 - k) Enter rise time until the measured rise time is close to the specified value (200 ps).
 - l) Click **Marker Search** and select “Rise Time” (10 – 90 %) to turn off the

Keysight MOI for USB 2.0 Connectors & Cable Assemblies Compliance Tests

marker.

m) Click **T31 (T42)**.

n) Press **Display > Equation** to turn on the equation editor.

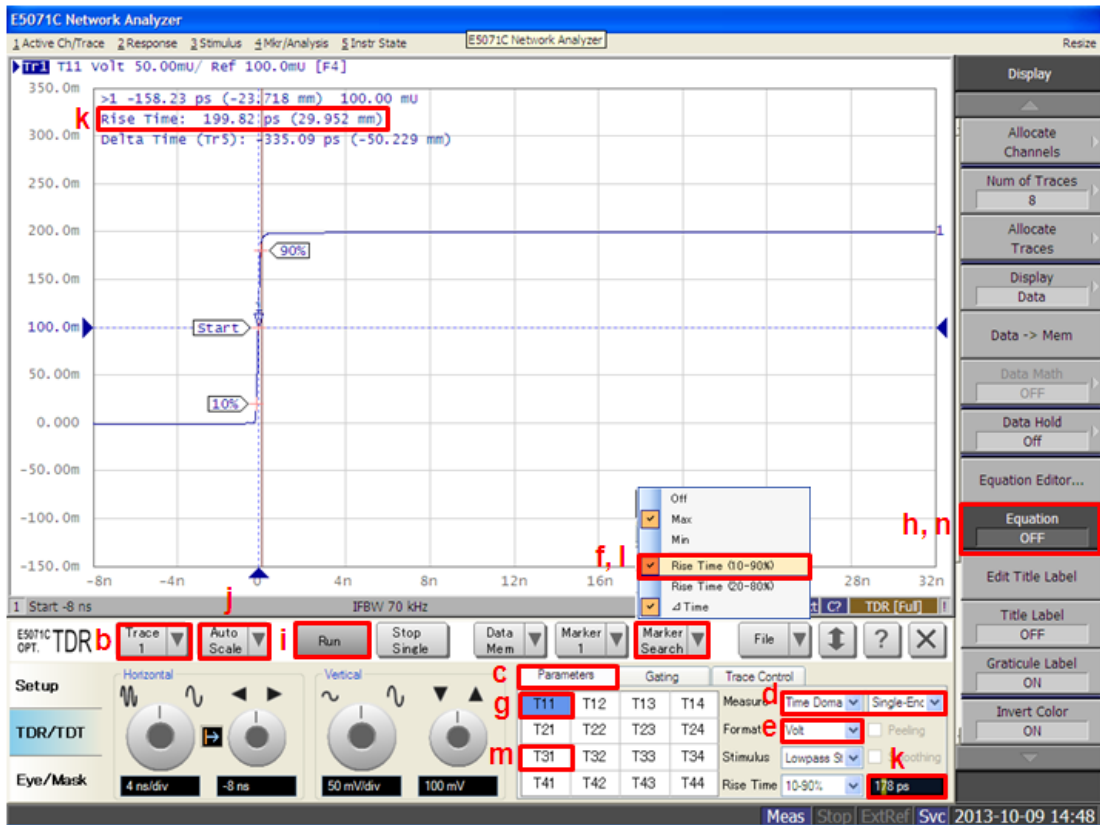

- Trace 1 (Trace 5) (Adjust effective rise time for Trace 1 then Trace 5)
 - a) Connect 1/2 Thru standard to the E5071C port 1 (port 3) with the RF cable.
 - b) Click **Trace 1 (Trace 5)**.
 - c) Click **Parameter** tab.
 - d) Select Measure to “Time Domain” and “Single Ended”.
 - e) Select Format to “Volt”.
 - f) Click **Marker Search** and select “Rise Time” (10 – 90 %).
 - g) Click **T11 (T33)**.
 - h) Click **Run** to measure the rise time on the screen.
 - i) Click **Auto Scale** and select “X&Y”.
 - j) Enter rise time until the measured rise time is close to the specified value (200 ps).
 - k) Click **Marker Search** and select “Rise Time” (10 – 90 %) to turn off the marker.
 - l) Select Measure to “Time Domain” and “Differential”.
 - m) Select Format to “Impedance”.

Keysight MOI for USB 2.0 Connectors & Cable Assemblies Compliance Tests

- n) Click **Tdd11 (Tdd22)**.
- Trace 2 (Trace 6) (Adjust effective rise time for Trace 2 then Trace 6)
 - o) Connect 1/2 Thru standard to the E5071C port 1 (port 3) with the RF cable.
 - p) Click **Trace 2 (Trace 6)**.
 - q) Click **Parameter** tab.
 - r) Select Measure to “Time Domain” and “Single Ended”.
 - s) Select Format to “Volt”.
 - t) Click **Marker Search** and select “Rise Time” (10 – 90 %).
 - u) Click **T11 (T33)**.
 - v) Click **Run** to measure the rise time on the screen.
 - w) Click **Auto Scale** and select “X&Y”.
 - x) Enter rise time until the measured rise time is close to the specified value (200 ps).
 - y) Click **Marker Search** and select “Rise Time” (10 – 90 %) to turn off the marker.
 - z) Select Measure to “Time Domain” and “Differential”.
 - aa) Select Format to “Impedance”.
 - bb) Click **Tcc11 (Tcc22)**.
- Trace 3
 - a) Connect 1/2 Thru standard to the E5071C port 1 with the RF cable.
 - b) Click **Trace 3**.
 - c) Click **Parameter** tab.
 - d) Select Measure to “Time Domain” and “Single Ended”.
 - e) Select Format to “Volt”.
 - f) Click **Marker Search** and select “Rise Time” (10 – 90 %).
 - g) Click **T11**.
 - h) Click **Run** to measure the rise time on the screen.
 - i) Click **Auto Scale** and select “X&Y”.
 - j) Enter rise time until the measured rise time is close to the specified value (200 ps).
 - k) Click **Marker Search** and select “Rise Time” (10 – 90 %) to turn off the marker.
 - l) Select Measure to “Time Domain” and “Differential”.
 - m) Click **Tdd21**.

5.4.Measurement

5.4.1. Cable Impedance (High/Full-Speed)

The cable impedance measurement insures the signal conductors have the proper impedance.

1. Connect the E5071C ports (port 1 to 4) to the test fixture ports with RF cables.

E5071C	Port 1	Port 2	Port 3	Port 4
Test Fixtures	TF1 D+	TF1 D-	TF2 D+	TF2 D-

Note: Unused fixture pots should be terminated with 50 ohm terminators.

2. Press **Channel Next** to select Channel 1.
3. Press **Channel Max** to maximize Channel 1 on the screen.
4. Press **Trace Max** to maximize the selected trace on the screen.
5. Select **Trace 1 (Tdd11)**.
6. Click **Stop Single**.
7. Confirm the measured impedance is within the limit shown below.

Impedance	Min	Max	Unit	Note
Differential impedance (Z_0)	76.5	103.5	Ohm	90 ohm +- 15%
Common-mode impedance (Z_{CM})	21	39	Ohm	30 ohm +- 30%

8. Select **Trace 5** and repeat step 6 to step 7 for the impedance measurement at the device-end of DUT (Tdd22).
9. Select **Trace 2** and repeat step 6 to step 7 for the impedance measurement at the device-end of DUT (Tcc11).
10. Select **Trace 6** and repeat step 6 to step 7 for the impedance measurement at the device-end of DUT (Tcc22).

5.4.2. Propagation Delay

The propagation delay measurement is to verify the end-to-end propagation of the cable.

1. Connect the E5071C ports (port 1 to 4) to the test fixture ports with RF cables.

E5071C	Port 1	Port 2	Port 3	Port 4
Test Fixtures	TF1 D+	TF1 D-	TF2 D+	TF2 D-

2. Press **Channel Next** to select Channel 1.
3. Press **Channel Max** to maximize Channel 1 on the screen.
4. Press **Trace Max** to maximize the selected trace on the screen.
5. Select **Trace 3 (Tdd21)**.
6. Click **Stop Single**.
7. Read marker value of Trace 3 on the screen.
8. Confirm the measured propagation delay is within the limit shown below.

Speed Mode	Limit

Full/High-Speed	If the time at the rising edge (T_{FSCBL}) < 26 nsec then PASS. Otherwise Fail
Low-Speed	If the time at the rising edge (T_{LSCBL}) < 18 nsec then PASS. Otherwise Fail.

9. Confirm the cable delay is < 5.2 ns/m.

5.4.3. Propagation Delay Skew

The propagation delay skew measurement insures the signal on both D+ and D- lines arrive at the receiver at the same time.

1. Connect the E5071C ports (port 1 to 4) to the test fixture ports with RF cables.

E5071C	Port 1	Port 2	Port 3	Port 4
Test Fixtures	TF1 D+	TF1 D-	TF2 D+	TF2 D-

2. Press **Channel Next** to select Channel 1.
3. Press **Channel Max** to maximize Channel 1 on the screen.
4. Press **Trace Max** to maximize the selected trace on the screen.
5. Select **Trace 4 (T31)**.
6. Click **Stop Single**.

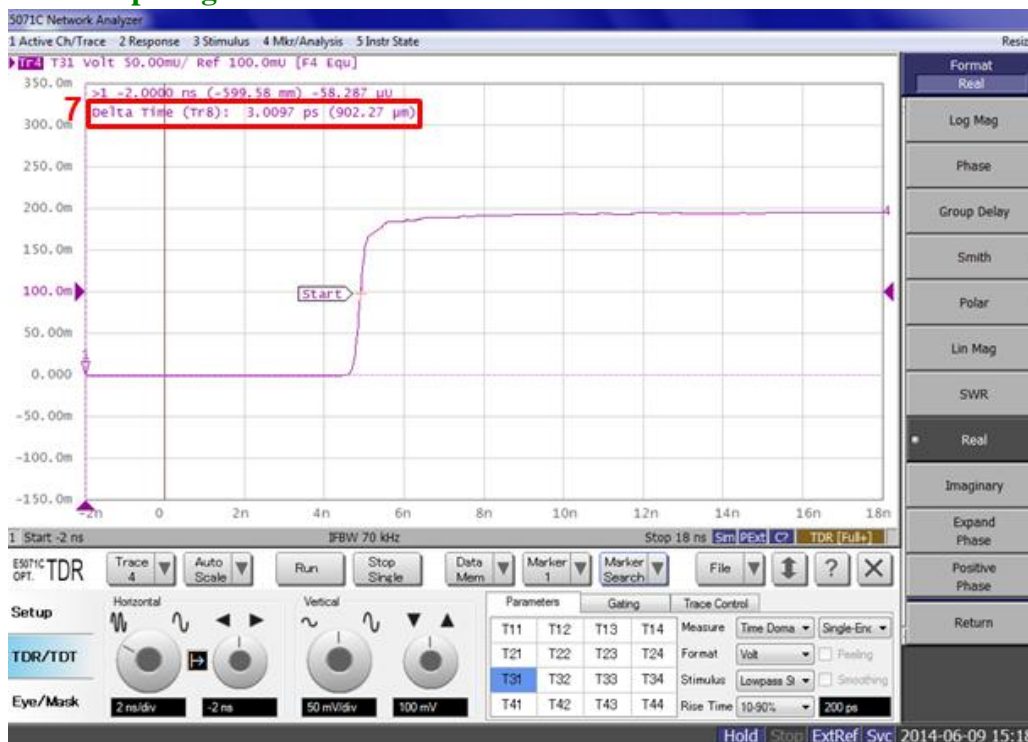

7. Read Delta Time (Tr8) on the E5071C screen.
8. Confirm the measured propagation delay skew. If the skew (T_{SKEW}) is lower than 100 psec, then PASS. Otherwise, FAIL.

5.4.4. Signal Pair Attenuation (High/Full-Speed)

1. Connect the E5071C ports (port 1 to 4) to the test fixture ports with RF cables.

E5071C	Port 1	Port 2	Port 3	Port 4
Test Fixtures	TF1 D+	TF1 D-	TF2 D+	TF2 D-

2. Press **Channel Next** to select Channel 2 and Trace 1 (Sdd21).
3. Press **Channel Max** to maximize Channel 1 on the screen.
4. Press **Trigger > Single**.
5. Confirm the measured signal pair attenuation is within the limit shown below.

Start Frequency	Stop Frequency	Start Limit	Stop Limit
64 kHz	256 kHz	-80 mdB	-110 mdB
256 kHz	512 kHz	-110 mdB	-130 mdB
512 kHz	772 kHz	-130 mdB	-150 mdB
772 kHz	1 MHz	-150 mdB	-200 mdB
1 MHz	4 MHz	-200 mdB	-390 mdB
4 MHz	8 MHz	-390 mdB	-570 mdB
8 MHz	12 MHz	-570 mdB	-670 mdB
12 MHz	24 MHz	-670 mdB	-950 mdB
24 MHz	48 MHz	-950 mdB	-1.35 dB
48 MHz	96 MHz	-1.35 dB	-1.9 dB
96 MHz	200 MHz	-1.9 dB	-3.2 dB
200 MHz	400 MHz	-3.2 dB	-5.8 dB

6. [Appendix] Manual Setup

The procedures of manual setup for time-domain and frequency-domain measurements are introduced in the section. All the following parameters are saved in the E5071C's state file, which is available at: www.keysight.com/find/ena-tdr_USB2-cabcon

6.1.Channel & Trace Setup

If TDR setup wizard is shown when launching the TDR software, click **Close** button in the TDR setup wizard main window.

1. Open **Setup** tab in the TDR software.
2. Click **Preset** to preset the instrument. Click **OK** in a dialog box to continue.
3. Set **DUT Topology** to “Differential 2-Port”. Click **OK** in a dialog box.
4. Click **Advanced Mode**>>.

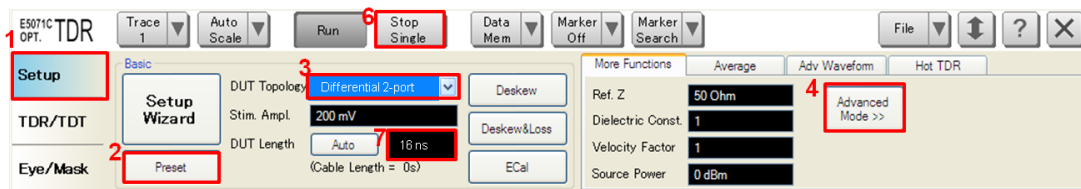

5. A dialog box appears requesting for confirmation. Then click **Yes**. (Clear the check box for “Use Advanced Calibration Methods”)

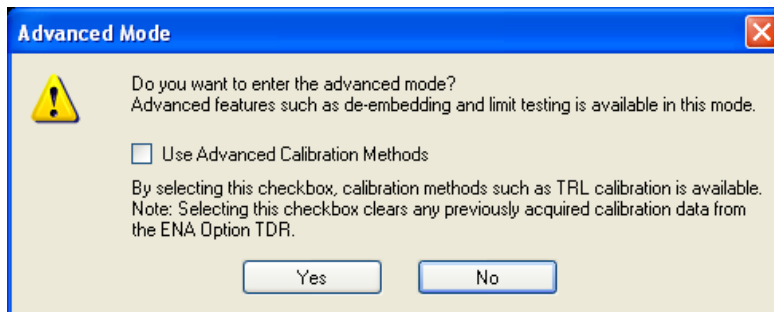

6. Click **Stop Single**.
7. Set DUT Length to “16 ns”.
8. Open **TDR/TDT** tab.
9. Click **Trace Control** tab.
10. Clear **Time** and **Marker** check box under Coupling.

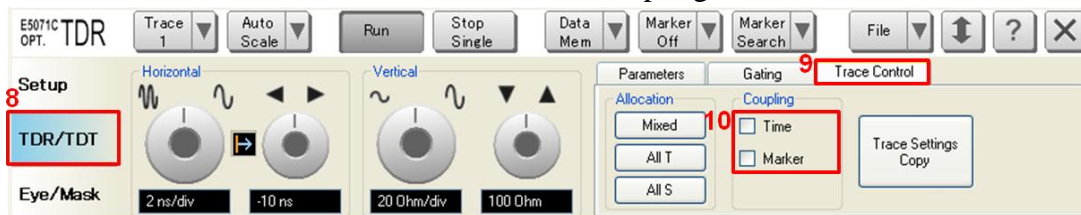

11. Press **Display** > **Allocate Channels** > .

12. Press **Channel Max** to maximize the screen of channel 1.

6.2.Cable Impedance (High/Full-Speed)

1. Select **Trace 1**.
2. Open **Parameters** tab.
3. Select “Time Domain” and “Differential” for Measure.
4. Select Format to “Impedance”
5. Select **Rise Time** to 10-90% and input value (200 ps).
6. Click **Tdd11**.
7. Input vertical scale (10 Ohm/div) and vertical position (50 Ohm).

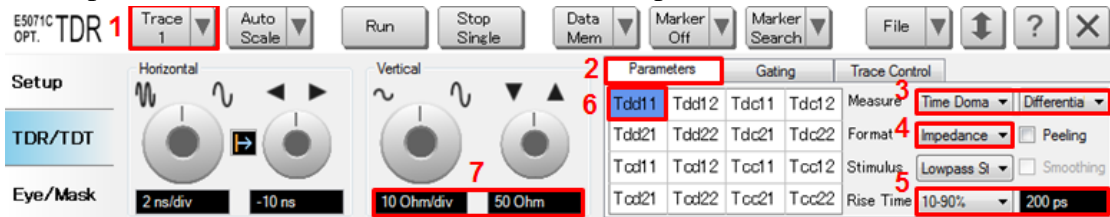

8. Open **Trace Control** tab.
9. Click **Trace Settings Copy** to launch trace copy dialog box.

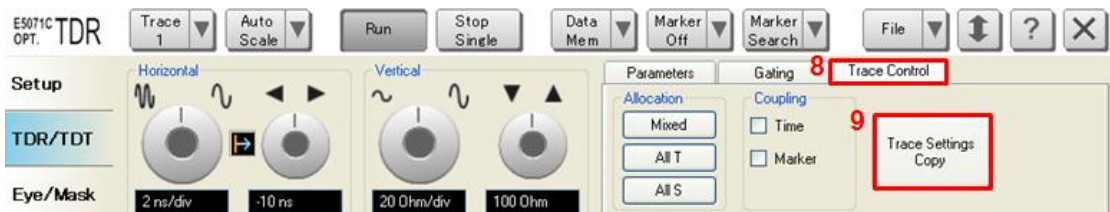

10. Select the Trace 1 in the From list.
11. Select the Trace 5 in the To list.
12. Click **Copy**.
13. Click **Close**.

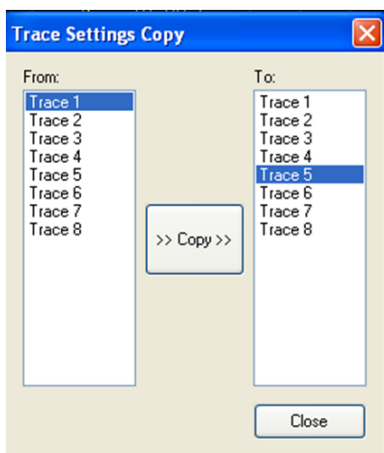

14. Select **Trace 5**.
15. Open **Parameter** tab.
16. Click **Tdd22**.

Keysight MOI for USB 2.0 Connectors & Cable Assemblies Compliance Tests

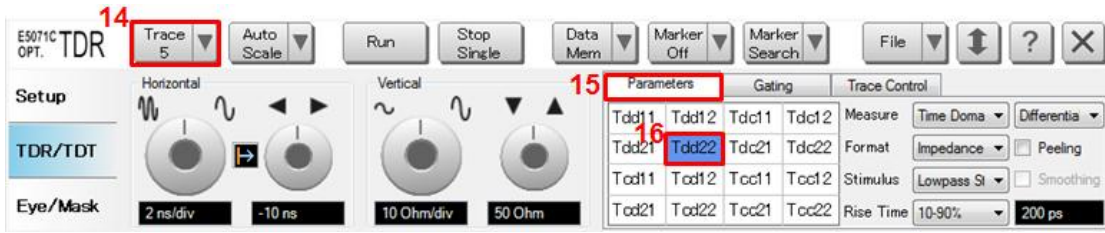

17. Select **Trace 2**.
18. Open **Parameters** tab.
19. Select “Time Domain’ and “Differential” for Measure.
20. Select Format to “Impedance”
21. Select **Rise Time** to 10-90% and input value (200 ps).
22. Click **Tcc11**.
23. Input vertical scale (5 Ohm/div) and vertical position (0 Ohm).

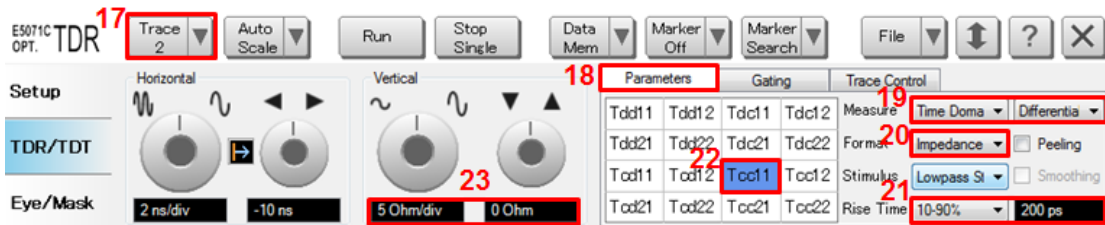

24. Open **Trace Control** tab.
25. Click **Trace Settings Copy** to launch trace copy dialog box.

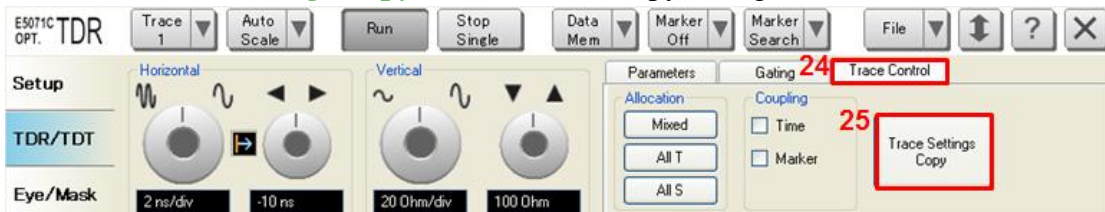

26. Select the Trace 2 in the From list.
27. Select the Trace 6 in the To list.
28. Click **Copy**.
29. Click **Close**.

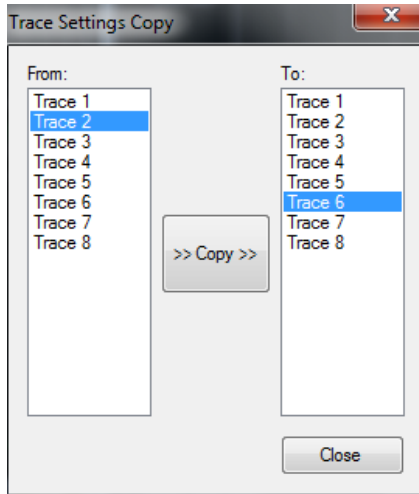

30. Select **Trace 6**.
31. Open **Parameter** tab.
32. Click **Tcc22**.

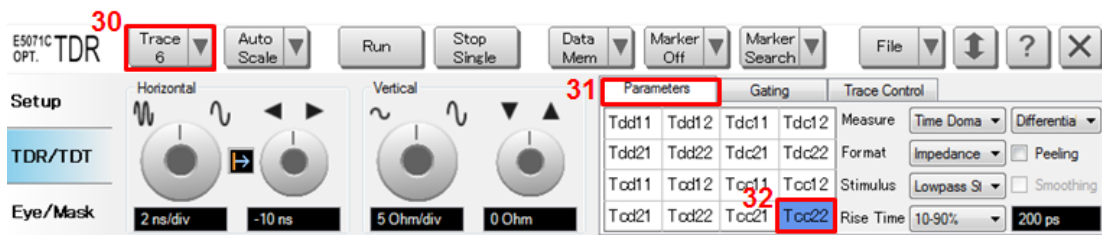

6.3.Propagation Delay

1. Select **Trace 3**.
2. Open **Parameters** tab.
3. Select “Time Domain” and “Differential” for Measure.
4. Select Formant to “Volt”.
5. Select **Rise Time** to 10-90% and input value (200 ps).
6. Click **Tdd21**.
7. Input vertical scale (100 mV/div) and vertical position (200 mV).

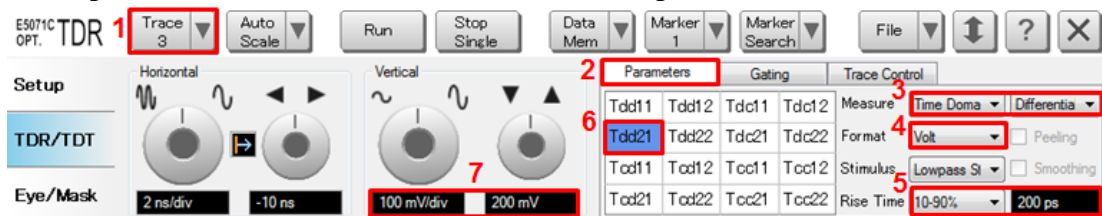

8. Press **Marker Search** > **Target** > **Target Value** and enter 200 mU.
9. Press **Marker Search** and turn on **Tracking**.

6.4. Propagation Delay Skew

6.4.1. Parameter Setup

1. Select **Trace 4**.
2. Open **Parameters** tab.
3. Select “Time Domain” and “Single-Ended” for Measure.
4. Select Formant to “Volt”.
5. Select **Rise Time** to 10-90% and input value (200 ps).
6. Click **T31**.
7. Input vertical scale (50 mV/div) and vertical position (100 mV).

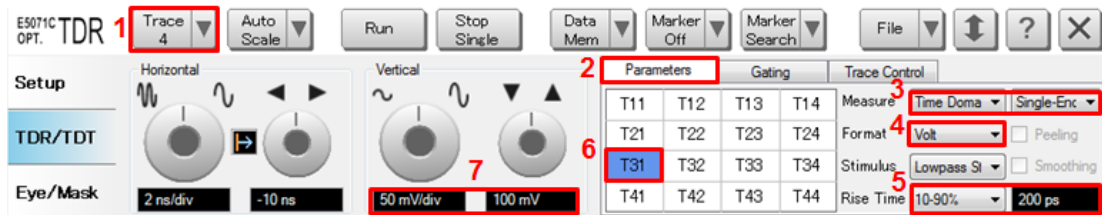

8. Open **Trace Control** tab.
9. Click **Trace Settings Copy** to launch trace copy dialog box.

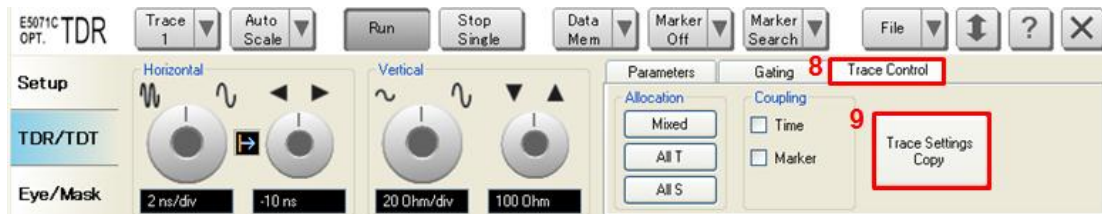

10. Select Trace 4 in the From list.
11. Select Trace 8 in the To list.
12. Click **Copy**.
13. Click **Close**.

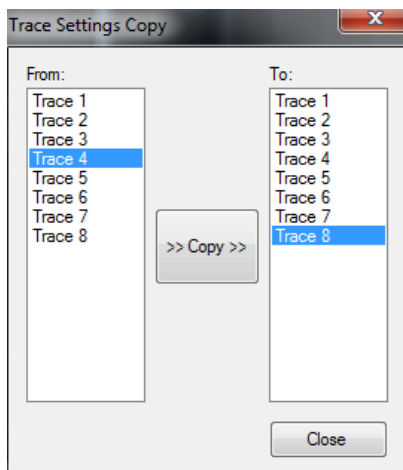

14. Select **Trace 8**.
15. Open **Parameters** tab.
16. Click **T42**.

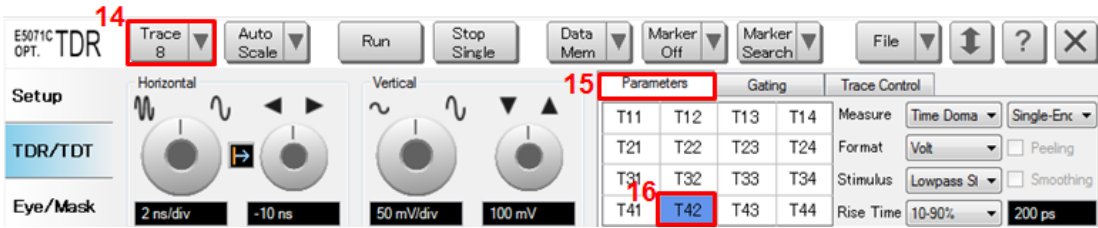

17. Select **Trace 4** (T31).
18. Click **Marker Search** and select **Δ Time**.
19. Check **Δ Time**.
20. Select **Target (Stop)** to Trace 8 and click **OK**.

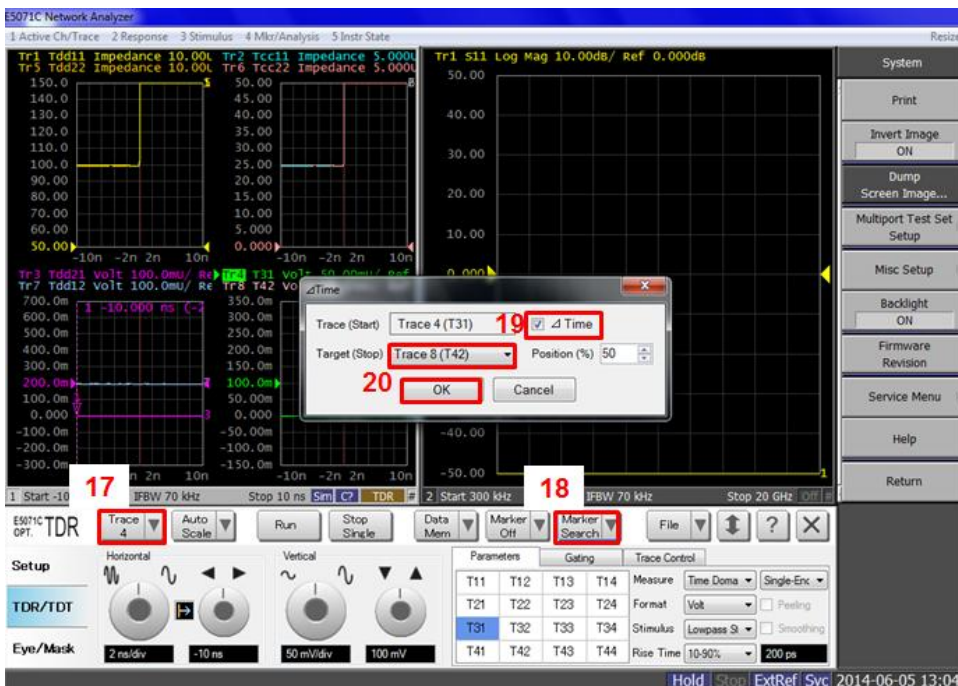

6.4.2. Crosstalk Compensation

1. Select **Trace 4**.
2. Press **Display** > **Equation Editor...** > Enter an equation “**S31-S32**”.
3. Check **Enabled** to enable the equation on trace.
4. Click **Apply**.
5. Click **Close**.

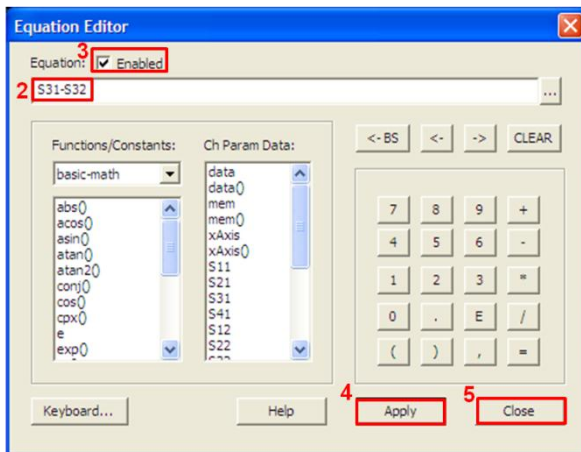

6. Select **Trace 8**.
7. Press **Display** > **Equation Editor...** > Enter an equation “**S42-S41**”.
8. Check **Enabled** to enable the equation on trace.
9. Click **Apply**.
10. Click **Close**.

6.5. Common Parameters Setup for Frequency-domain Measurements

1. Press **Channel Next** to select Channel 2.
2. Press **Sweep Setup** > **Points** and set to “1,601”.
3. Press **Sweep Setup** > **Sweep Type** > **Log Freq**.
4. Press **Start** > Set start value to “64 kHz”.
5. Press **Stop** > Set stop value to “400 MHz”.
6. Press **Avg** > Set **IF Bandwidth** to “1 kHz”.
7. Press **Analysis** > **Fixture Simulator** and turn it **ON**.
6. Press **Analysis** > **Fixture Simulator** > **Topology** > **Device** > **Bal-Bal**
7. Press **Analysis** > **Fixture Simulator** > **Topology** > **Port1 (bal)** > **1-2**
8. Press **Analysis** > **Fixture Simulator** > **Topology** > **Port2 (bal)** > **3-4**
9. Press **Analysis** > **Fixture Simulator** > **BalUn ON All Traces** to enable mixed-mode S-parameters (i.e. Sdd21) measurements on all traces.
10. Press **Analysis** > **Fixture Simulator** > **Port ZConversion** > **Port1 Z0 Real** and set the port impedance to “45 ohm”.
11. Press **Analysis** > **Fixture Simulator** > **Port ZConversion** > **Port2 Z0 Real** and set the port impedance to “45 ohm”.
12. Press **Analysis** > **Fixture Simulator** > **Port ZConversion** > **Port3 Z0 Real** and set the port impedance to “45 ohm”.
13. Press **Analysis** > **Fixture Simulator** > **Port ZConversion** > **Port4 Z0 Real** and set the port impedance to “45 ohm”.
14. Press **Analysis** > **Fixture Simulator** > **Port ZConversion** > **Port ZConversion** and turn **ON**.

Note: Signal pair attenuation test requires the test frequency from 64 kHz at step 4. When using E5071C-4x5, the lower frequency is limited to either 100 kHz or 300 kHz depending on the frequency option.

6.6.Signal Pair Attenuation (High/Full-Speed)

1. Press **Meas** > **Sdd21**.
2. Press **Scale** > **Scale/Div** to 1 dB/div.
3. Press **Scale** > **Reference Value** to -4 dB.

6.7.Defining Limit Line Tables

1. Press **Trace Next** to select trace to set the limit line table.
2. Press **Analysis** > **Limit Test** > **Limit Line** and turn it **ON** to display limit lines.
3. Press **Analysis** > **Limit Test** > **Edit Limit Line** to edit the limit line table.

Type	Begin Stimulus	End Stimulus	Begin Response	End Response
1	MAX	0 s	600 ps	105 u
2	MIN	0 s	600 ps	75 u
3				

4. Press **Analysis** > **Limit Test** > **Limit Test** and turn it **ON**.
5. Press **Analysis** > **Limit Test** > **Fail Sign** to switch the fail sign ON/OFF. When turned on, the Fail sign is displayed on the E5071C's screen, if one or more failed traces are within the channel.
6. Press **System** > **Misc Setup** > **Beeper** > **Beep Warning** to turn ON/OFF the warning beeper.

7. [Appendix] Defining SOLT Calibration Kit

The SOLT calibration kit file is defined with the E5071C before performing the calibration. Refer to the values defined by the fixture.

1. Create a new cal kit file.
 - A) Press **Cal** > **Cal Kit** and select **User** to setup a cal kit definition file.
 - B) Press **Cal** > **Modify Cal Kit** > **Label Kit (User)** and enter name of new cal kit file. (i.e. USB-HS).
2. Define short standard.
 - A) Press **Cal** > **Modify Cal Kit** > **Define STDs** > **1.No Name** > **Label** and enter "Short".
 - B) Press **Cal** > **Modify Cal Kit** > **Define STDs** > **1.Short** > **STD Type** and select **Short**.
 - C) Press **Cal** > **Modify Cal Kit** > **Define STDs** > **1.Short** > **Offset Delay** and enter the value of short standard. (i.e. 0.0000 s)
 - D) Press **Cal** > **Modify Cal Kit** > **Define STDs** > **1.Short** > **Offset Z0** and enter the value of the short standard. (i.e. 50.000 ohm)
 - E) Press **Cal** > **Modify Cal Kit** > **Define STDs** > **1.Short** > **Offset Loss** and enter the value of the short standard. (i.e. 0.0000 ohm/s)
 - F) Press **Cal** > **Modify Cal Kit** > **Define STDs** > **1.Short** > **Min. Frequency** and enter the value of the short standard. (i.e. 0.0000 Hz)
 - G) Press **Cal** > **Modify Cal Kit** > **Define STDs** > **1.Short** > **Max. Frequency** and enter the value of the short standard. (i.e. 10.000 GHz)
 - H) Press **Cal** > **Modify Cal Kit** > **Define STDs** > **1.Short** > **Media** and select **Coaxial**.
3. Define open standard.
 - A) Press **Cal** > **Modify Cal Kit** > **Define STDs** > **2.No Name** > **Label** and enter "Open".
 - B) Press **Cal** > **Modify Cal Kit** > **Define STDs** > **2.Open** > **STD Type** and select **Open**.
 - C) Press **Cal** > **Modify Cal Kit** > **Define STDs** > **2.Open** > **Offset Delay** and enter the value of open standard. (i.e. 0.0000 s)
 - D) Press **Cal** > **Modify Cal Kit** > **Define STDs** > **2.Open** > **Offset Z0** and enter the value of the open standard. (i.e. 50.000 ohm)
 - E) Press **Cal** > **Modify Cal Kit** > **Define STDs** > **2.Open** > **Offset Loss** and enter the value of the open standard. (i.e. 0.0000 ohm/s)
 - F) Press **Cal** > **Modify Cal Kit** > **Define STDs** > **2.Open** > **Min. Frequency** and enter the value of the open standard. (i.e. 0.0000 Hz)
 - G) Press **Cal** > **Modify Cal Kit** > **Define STDs** > **2.Open** > **Max. Frequency** and

- enter the value of the open standard. (i.e. 10.000 GHz)
- H) Press **Cal** > **Modify Cal Kit** > **Define STDs** > **2.Open** > **Media** and select **Coaxial**.
4. Define load standard.
- A) Press **Cal** > **Modify Cal Kit** > **Define STDs** > **3.No Name** > **Label** and enter “Load”.
- B) Press **Cal** > **Modify Cal Kit** > **Define STDs** > **3.Load** > **STD Type** and select **Load**.
- C) Press **Cal** > **Modify Cal Kit** > **Define STDs** > **3.Load** > **Offset Delay** and enter the value of load standard. (i.e. 0.0000 s)
- D) Press **Cal** > **Modify Cal Kit** > **Define STDs** > **3.Load** > **Offset Z0** and enter the value of the load standard. (i.e. 50.000 ohm)
- E) Press **Cal** > **Modify Cal Kit** > **Define STDs** > **3.Load** > **Offset Loss** and enter the value of the load standard. (i.e. 0.0000 ohm/s)
- F) Press **Cal** > **Modify Cal Kit** > **Define STDs** > **3.Load** > **Min. Frequency** and enter the value of the load standard. (i.e. 0.0000 Hz)
- G) Press **Cal** > **Modify Cal Kit** > **Define STDs** > **3.Load** > **Max. Frequency** and enter the value of the load standard. (i.e. 500.00 MHz)
- H) Press **Cal** > **Modify Cal Kit** > **Define STDs** > **3.Load** > **Media** and select **Coaxial**.
- I) Press **Cal** > **Modify Cal Kit** > **Define STDs** > **3.Load** > **Length Type** and select **Fixed**.
5. Define thru standard.
- A) Press **Cal** > **Modify Cal Kit** > **Define STDs** > **4.No Name** > **Label** and enter “Thru”.
- B) Press **Cal** > **Modify Cal Kit** > **Define STDs** > **4.Thru** > **STD Type** and select **Delay/Thru**.
- C) Press **Cal** > **Modify Cal Kit** > **Define STDs** > **4.Thru** > **Offset Delay** and enter the value of thru standard. (i.e. 0.0000 s)
- D) Press **Cal** > **Modify Cal Kit** > **Define STDs** > **4.Thru** > **Offset Z0** and enter the value of the thru standard. (i.e. 50.000 ohm)
- E) Press **Cal** > **Modify Cal Kit** > **Define STDs** > **4.Thru** > **Offset Loss** and enter the value of the thru standard. (i.e. 0.0000 ohm/s)
- F) Press **Cal** > **Modify Cal Kit** > **Define STDs** > **4.Thru** > **Min. Frequency** and enter the value of the thru standard. (i.e. 0.0000 Hz)
- G) Press **Cal** > **Modify Cal Kit** > **Define STDs** > **4.Thru** > **Max. Frequency** and enter the value of the thru standard. (i.e. 10.000 GHz)
- H) Press **Cal** > **Modify Cal Kit** > **Define STDs** > **4.Thru** > **Media** and select **Coaxial**.
6. Specify sub class of cal kit.

Keysight MOI for USB 2.0 Connectors & Cable Assemblies Compliance Tests

- A) Press **Cal** > **Modify Cal Kit** > **Specify CLSs** > **Sub Class** > **Sub Class 1**.
- B) Press **Cal** > **Modify Cal Kit** > **Specify CLSs** > **Open** > **Set All** > **2.Open**.
- C) Press **Cal** > **Modify Cal Kit** > **Specify CLSs** > **Short** > **Set All** > **1.Short**.
- D) Press **Cal** > **Modify Cal Kit** > **Specify CLSs** > **Load** > **Set All** > **3.Load**.
- E) Press **Cal** > **Modify Cal Kit** > **Specify CLSs** > **Thru** > **Set All** > **4.Thru**.
- F)

Note: Line 1/2/3 are not used for USB 2.0 connectors and cable assemblies compliance tests because the SOLT calibration can be performed to 400 MHz using USB 3.0 official test fixture, which is the upper frequency for the frequency domain measurement.

- 7. Press **Cal** > **Modify Cal Kit** and select **Export Cal Kit...** to Save Cal Kit File (*.ckx).